



FF30

(example; exact model may vary)

This instruction handbook is for the daily users of the equipment.

Table of Contents

1	Introduction	4
1.1	FF30	4
1.2	Abbreviations in this manual	4
1.3	Symbols on the machine.....	4
1.4	Caution and employee safety.....	5
1.5	Essential training before daily use.....	5
1.6	References	5
1.7	Dismantling and disposal	5
2	General information	6
2.1	Unpacking and inspection	6
2.2	Receiving and storing the FF30	6
2.3	Mounting of support for inlet and outlet tray	6
2.4	Technical specifications	7
2.4.1	Dimensions.....	7
2.4.2	Buttons / Control panel	8
2.4.3	Services.....	9
2.4.4	Bottles, caps and trays.....	9
2.4.5	Ingress protection	9
2.4.6	Weight	9
2.4.7	Materials of construction	10
2.4.8	Fillers	10
3	Installation	11
3.1	Connections.....	11
3.2	Mounting of format parts	12
3.2.1	Bottle format parts.....	12
3.2.2	Screw cap format parts	13
4	Daily Use	14
4.1	Starting-up and running	14
4.1.1	Adjusting the round table inner bottle rail	14
4.1.2	Adjusting the inlet guide	14
4.1.3	Adjustment of the filling stand	15
4.2	Adjusting the capping sensor	15
4.3	Adjusting the height of capping head	16
4.4	Adjusting the capping torque.....	16
4.5	Adjustments.....	17
4.5.1	Index speed adjustment.....	17
4.5.2	Capping time adjustment	17
4.5.3	Round table speed adjustment.....	17
4.6	Production START and STOP	17
4.6.1	Manual placing of caps	18
4.6.2	Removing bottles from collection tray.....	18
4.7	Stepping bottles through the FF30	18
5	Malfunctioning.....	19
5.1	Start up alarms	19
5.2	Runtime alarms.....	19
5.3	Runtime warnings	21
5.4	Trouble shooting	21
6	Cleaning	22
6.1	Cleaning Frequency.....	22
6.2	Preparations for cleaning	22
6.3	Cleaning Guidance	22

6.4	Detergents or cleaning agents	22
7	Maintenance & service.....	23
7.1	Maintenance	23
7.1.1	Tension of toothed belt	23
7.1.2	Capping unit.....	23
7.1.3	Star wheel and bottle ejector.....	24
7.2	Service.....	25
7.3	Methods and frequency of inspections for safety functions	25
8	Declaration of conformity	26

1 Introduction

1.1 FF30

FF30 is a small-scale bottle handling, filling and capping machine.

A round table moves the bottles to the inlet, from which each bottle is moved further on by a star wheel.

Filling is performed automatically, and capping is semi-automatic.

After capping the bottle is pushed to the outlet tray by a bottle ejector.

FF30 is delivered without the external filler; in order to perform the filling, a filler must be connected. (See further information in section 2.4)

1.2 Abbreviations in this manual

App.	Approximately
A/R	Alarm / Reset
e.g.	As example
BPM	Bottles per minute
Fig.	Figure
Hz	Hertz
IH	Instruction Handbook
L/min	Litres per minute
Max.	Maximum
mA	milli Ampere
msec	milli seconds
PE	Protective Earth (electrical units safety measure)
RT	Round Table
VAC	Volt Alternating Current
VDC	Volts Direct Current
WMF	Watson-Marlow Flexicon a/s

1.3 Symbols on the machine

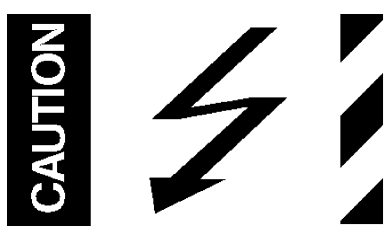
Warning against touching	Warning against high voltage
	

1.4 Caution and employee safety

This manual should be read before using the FF30.

It is strongly advised that

- Any kind of maintenance or cleaning of the machine not is carried out while power is connected
- Unauthorised / non-trained personnel should not open the cover of the electrical parts
- The machine is placed in such a way that it is not exposed to high humidity, high temperatures or other abnormal operating environment.
- The machine is not to be used in explosion hazardous environments.

1.5 Essential training before daily use

Read the section with *Daily Use*, thoroughly before using the machine.

Protective equipment and protective devices are installed:

- If the star wheel is jammed it will stop immediately
- The capping machine will stop if it is unable to reach lower position during capping; e.g. this way fingers or instruments will not be squeezed if they are placed between the cap and the capping head during production.

Always respect the symbols on the machine.

Cleaning must be performed as described in this IH.

1.6 References

N/A

1.7 Dismantling and disposal

Prior to dismantling, it must be observed that all services are disconnected, and fixing to other equipment is removed.

WM-Flexicon machines may not be disposed using normal refuse collection. The machines must be collected and disposed separately as they contain electrical components such as batteries, electrolyte capacitors, liquid crystal displays and printed circuit boards. Further information is available on www.wmflexicon.dk.



* (WEEE) DS/EN 50419

2 General information

2.1 Unpacking and inspection

Please check that all ordered items have been received and that no items are damaged during transport. In case of any defects or omissions, please contact WMF or your supplier immediately.

Note: FF15 is delivered with a commutation cable to be used with WM-Flexicon pumps, only.

2.2 Receiving and storing the FF30

Before unpacking or storing of the FF30 it should be checked if the crate is damaged.

In case of long-term storage of the FF30 before installation, the machine must be stored in the crate, and placed in a dry room. The crate is not water resistant.

2.3 Mounting of support for inlet and outlet tray

If the inlet tray or outlet tray have been removed during shipping they must be mounted as shown below. Use the supplied bolts and fasten them as shown below.

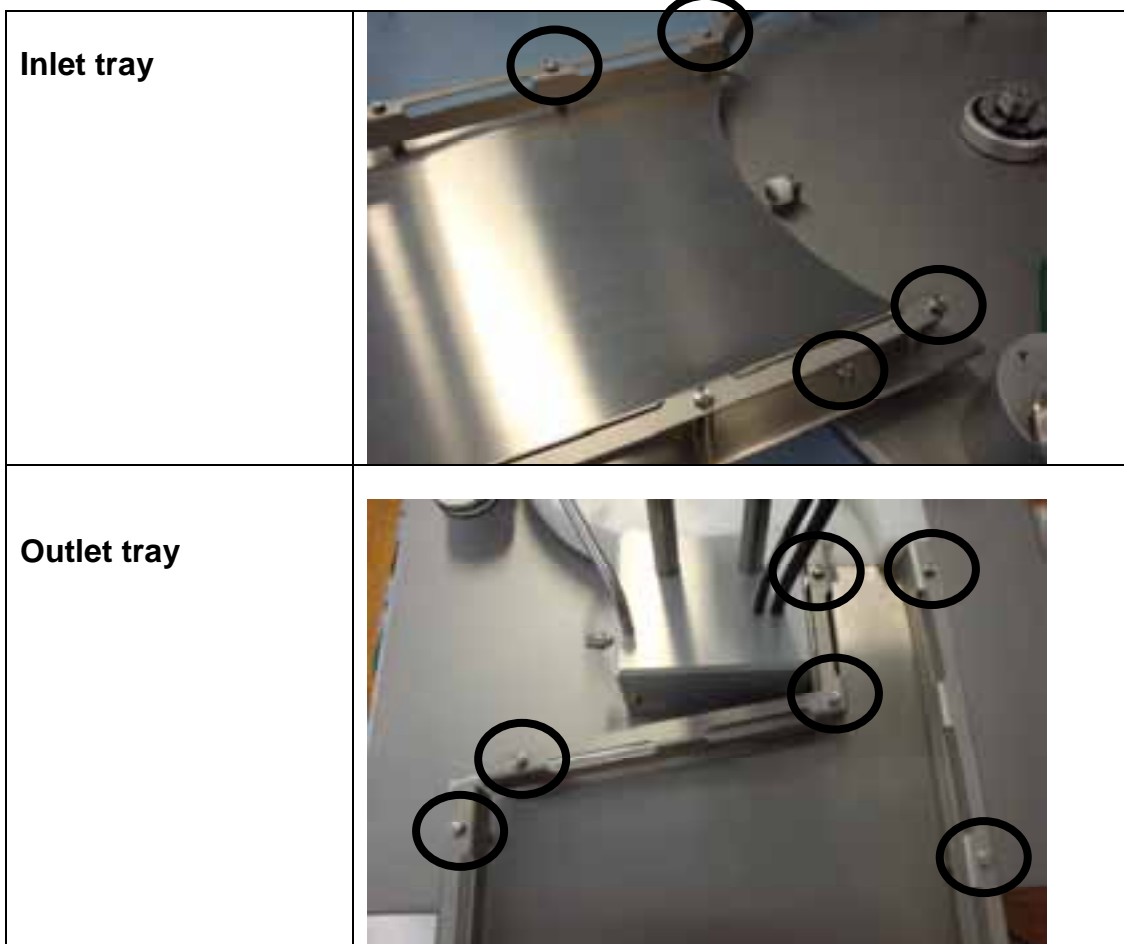

2.4 Technical specifications

2.4.1 Dimensions

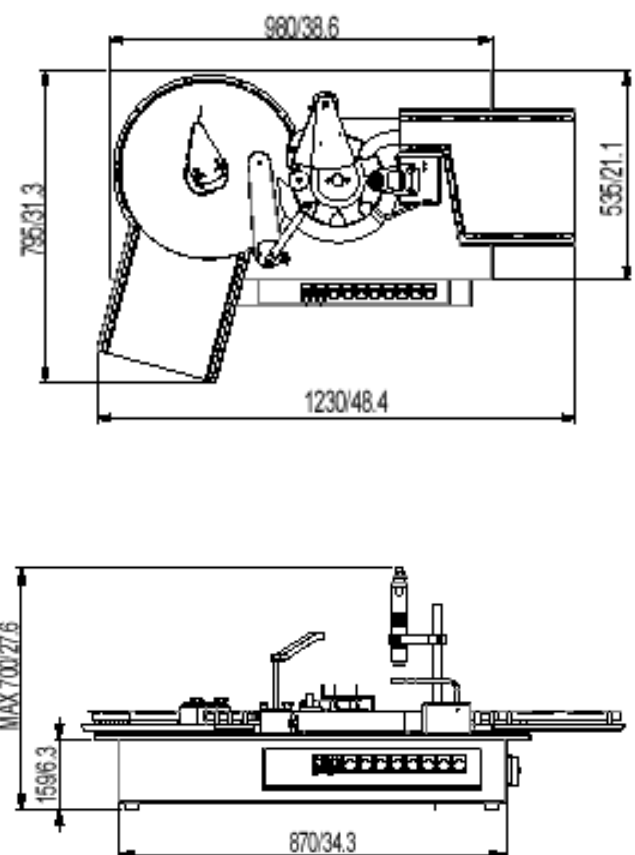
<p>Length: 1230 mm</p> <p>Width: 795 mm</p> <p>Height: max. 700 mm (incl. Feet)</p>	 <p>The image contains two technical drawings of the FF30 machine. The top drawing is a top-down view showing a large circular component on the left and a rectangular control panel on the right. Dimensions are: 960/38.6 mm (width of the main body), 795/31.3 mm (width of the circular component), 535/21.1 mm (height of the main body), and 1230/48.4 mm (total length). The bottom drawing is a side profile view showing the machine's height and depth. Dimensions are: MAX 700/27.6 mm (total height including feet), 159/6.3 mm (height of the main body), and 870/34.3 mm (depth of the main body).</p> <p>Dimensions: mm / inches</p>
---	--

2.4.2 Buttons / Control panel



ON/OFF – EMERGENCY SWITCH

Combined button: Main switch and Emergency switch for the entire FF30



POWER ON	Green indicator which lights when power is on.
ALARM / RESET	Push button for cancelling errors. The button flashes if an error occurs
READY	Green indicator which lights when FF30 is ready
FILL	Enables filling; signal to an external pump. White indicator lights when the FILLING function is active.
CAP	Enables capping. White indicator lights when the CAPPING function is active.
STEP	Push button. One push activates one step with the star wheel.
ADJUST	Push button for adjustment mode. White indicator lights when ADJUST is active.
START	Push button for starting and stopping production. White indicator lights when START is active
DELAY	Potentiometer for adjusting the delay between each indexation. 0,5 = minimum time (~ fast process of bottles), 10 = maximum time (~ slow process)
INLET SPEED	Potentiometer for setting the speed of the round table. 0,5 = slow 10 = fast

2.4.3 Services

All electrical systems are placed in the base cabinet.

Power supply:	110/230 VAC, 50/60Hz Earthed by the main power switch
Consumption:	300 W
Compressed air:	6 bar, clean and dry air
Consumption:	75 L/min at 20 BPM

Note:

Only authorised personnel can gain access to the installations.

The main power cable must be removed completely from power supply before the base cabinet is opened.

2.4.4 Bottles, caps and trays

Bottle sizes

Diameter	Max Ø50 mm.
Height	Max 110 mm.

Cap sizes

Diameter	Max Ø50 mm.
Height	Max 40 mm.

Tray size inlet / outlet

	Inlet	Outlet
Length / width*	290 mm / 260 mm	280-320 mm / 285 mm
Height of rail	30 mm	30 mm

*note – the trays are not rectangular. See picture on the front page.

2.4.5 Ingress protection

Ingress protection IP52

2.4.6 Weight

Weight: app. 60 kg

2.4.7 Materials of construction

- AISI304 stainless steel
- anodised aluminium
- Polyacetal

2.4.8 Fillers

A peristaltic filler or gear filler must be connected to FF30.

Optional fillers when filling are:

- PF6 Peristaltic filler
- 520 Di peristaltic filler
- DF32 Positive displacement filler
- GF30 gearfiller

3 Installation

3.1 Connections

FF30 must be placed on a stable and horizontal bedplate.

The mains cable (1) is connected to a single-phase power supply with earth. Compressed air is connected to (2) by use of the supplied quick release clutch.

All exhaust air is collected and exhausted through the exhaust filter (3)



3

2

1

The filler is connected to (4).

RS485 (5) is used for “remote access” (e.g. during service, or monitoring)



5





4

3.2 Mounting of format parts

3.2.1 Bottle format parts

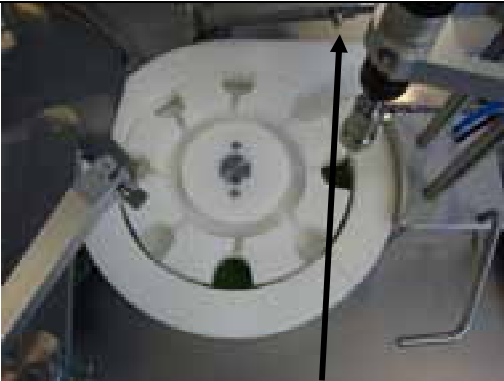
A set of bottle format parts consists of 1 star wheel and 3 guides. All 4 are marked with one number which together composes the customised parts for one specific bottle size. The number does not have any reference to the bottle size; it is merely a number which is engraved on the parts to ensure that the matching parts can be recognized.

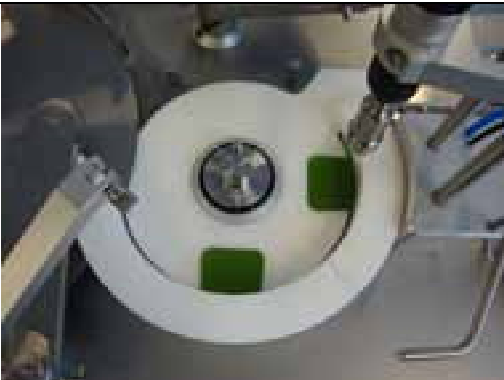
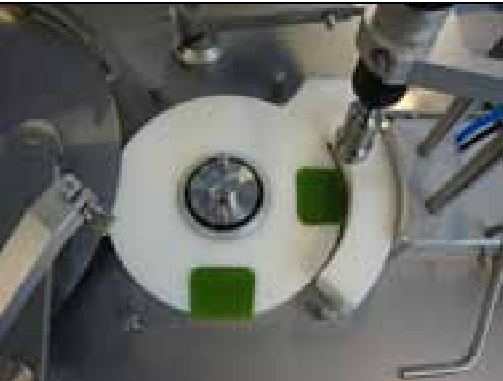

Change of bottle format parts

	
<p>Remove the finger screw and dismount the bottle ejector.</p>	<p>Move the plate with the inlet sensor to the right</p>
	
<p>Move the star wheel</p>	<p>Finally move the guides one by one...</p>
	
	<p>When the last guide has been removed another size of format parts can be mounted. This is done the opposite way of the dismounting procedure.</p>



3.2.2 Screw cap format parts

Screw cap format parts consist of 1 single capping head. If several sizes of capping heads have been ordered, each size is marked with one number which together with the bottle format parts composes the customised parts for one specific bottle size. The number does not have any reference to the bottle size; it is merely a number which is engraved in the parts to ensure that the matching parts can be recognized. E.g. bottle format parts marked with the number 1 – match the capping head marked with the number 1.

Mounting of capping unit

		
Mount the capping unit on the two steel columns		Mount the two hoses for compressed air.

Change of capping head

		
Hold the head with one hand	And with the other hand press the quick coupling down	Pull the head down until it is released from the coupling

When mounting another size of capping head, it is not necessary to touch the quick coupling. Just press the head into the coupling until it clicks.

4 Daily Use

4.1 Starting-up and running

Installation section must be carried out before this chapter can be performed.

When the main switch is turned, an initial procedure starts and secure that the machine is ready for production. The POWER ON will light if no errors are detected.

In case of error detection during initial procedure the ALARM button will flash.

See section 5 regarding alarms.

4.1.1 Adjusting the round table inner bottle rail

Adjust the inner bottle rail by loosening the bolts (finger screws) and move the rail in or out; depending on bottle size. The bottles should be stopped by the rail in such a way that only one bottle at a time can pass the space between the inner and outer rail.



4.1.2 Adjusting the inlet guide

Adjust the inlet guide by loosening the bolts (finger screws) and move it to the right or left; depending on bottle size. The bottles should be let to the first position of the star wheel; never to the outside of the star wheel.



Correct adjustment



Wrong adjustment

4.1.3 Adjustment of the filling stand



Loosen the finger screw at the bottom of the filling stand.
Adjust the filling stand and the filling nozzle over the center of the bottle – over the second bottle in the star wheel.
The nozzle tip should only be a few millimetres away from the bottle top to avoid squirt of product.

4.2 Adjusting the capping sensor





Place a bottle with a cap in front of the sensor.
The cap must be placed detachable on the top of the bottle – not screwed.
Loosen the finger screw of the sensor and adjust until the light is just below the top of the cap.

4.3 Adjusting the height of capping head

Adjusting the height of the capping head must be repeated until the cap is tightened satisfactorily. A correct capping function is depending on the placement of the capping unit, and the type of cap and bottle.

	<p>Place a bottle with a cap underneath the capping unit. The cap must be tightened into end position. Press ADJUST, to lower the capping unit.</p> <p>Loosen the finger screw on the capping unit and lower it until the capping head is resting on the top of the screw cap. Fasten the finger screw.</p> <p>Now press ADJUST again, and the capping head will return to top position.</p> <p>Loosen the finger screw once more, and lower the capping unit app. 5-10 mm before tightening the finger screw again.</p>
---	--

4.4 Adjusting the capping torque

		
<p>Pull the black clutch casing sleeve down.</p>	<p>Turn the capping head until the adjustment lock plate is visible through the slot.</p>	<p>Insert a screwdriver and adjust torque by turning. Increase = clockwise Decrease = counter clockwise</p>

4.5 Adjustments

4.5.1 Index speed adjustment

Speed is set via the DELAY function. The lower value, the faster the bottles will move from inlet to filling and capping.

- Press ADJUST (the capping machine will enter lower position)
- Set speed on DELAY potentiometer, 0,5 = minimum time (~ fast process), 10 = maximum time (~ slow process)
- Press START to save the value (note the value)
- Turn DELAY back to 0
- Press ADJUST again to return to normal mode

The value is not saved when the machine is turned off.

4.5.2 Capping time adjustment

Capping time adjustment is set via the DELAY function. The lower value the adjustment is set at, the shorter time the capping head will use on screwing the cap into place. Note: If the time is too short the cap might not be fastened enough.

- Press ADJUST (the capping machine will enter lower position)
- Set speed on DELAY potentiometer, 0,5 = minimum time (~ fast), 10 = maximum time (~ slow)
- Press CAP to save the value (note the value)
- Turn DELAY back to 0
- Press ADJUST again to return to normal mode

The value is not saved when the machine is turned off.

4.5.3 Round table speed adjustment

See section 2.4.2

4.6 Production START and STOP

FF30 is ready for production when:

- bottles are placed on the inlet tray
- the inner bottle rail is adjusted
- the inlet guide is adjusted
- filling stand is adjusted
- the external filler is connected and ready
- capping sensor is adjusted
- height of capping head is set
- the Index speed is set, if necessary
- READY indicator is ON

Production can begin by pressing START. FILL and CAP must be activated before pressing START. When a bottle is detected at the inlet the star wheel will begin the indexing, and the activated functions start.

The time/pause between 2 indexing cycles can be adjusted via the DELAY function.

If a function has a longer cycle time than the setting of the DELAY, the indexing will be halted until all functions have finished the cycle.

4.6.1 Manual placing of caps

Caps are to be applied on the bottles after filling has been performed.

The cap is placed with a small twist to prevent the cap from falling off during the following indexing.

The cap sensor is only active when the CAP button has been activated.

If a bottle enters in front of the sensor without a cap the FF30 will stop. Place the cap manually and press CAP to continue production; or press STEP to end automatic production – the star wheel will now move one position forward.

4.6.2 Removing bottles from collection tray

When the collection tray is full the operator must stop the machine and empty the tray.

When the outlet tray is full the operator can choose to stop the machine and empty the tray or to empty the tray when production is ongoing and the tray is not packed.

4.7 Stepping bottles through the FF30

Pressing the STEP button will perform one indexing; the star wheel will move all bottles one function forward. From inlet to filling > from filling to capping > from capping to outlet.

When pressing STEP, the star wheel and the bottle ejector will move whether a bottle is present or not.

If filling is desired this must be activated manually from the FILL button.

If the CAP function is ON a cap must be applied to the bottle manually after the filling is performed.

By using the STEP function the star wheel can be emptied at the end of a batch.

If the STEP button is held down constantly the functions continue as long as there are bottles in the star wheel.

5 Malfunctioning

The FF30 is equipped with control functions, which will stop the machine in the event of malfunctioning. If a function error is detected, the yellow ALARM/RESET (A/R) button will begin to flash and the FF30 will stop.

5.1 Start up alarms

The alarm number is identified by observing both the A/R button together with the READY indicator. By counting the number of flashes of the A/R button in between each flash of the READY indicator the alarm number can be identified.

Alarm No	Description	Actions
1	Internal RS485 communication failure with Round Table (RT) Controller	Open machine and check fuses, cables etc.
2	RT Controller not READY	Only used with diving nozzle, for the RT controller to be backwards compatible.
3	Capping station not in top position	First check compressed air and air connection. Next open machine and check sensor and mechanical parts
4	Indexing start-wheel is not in HOME position	First check for things obstructing the star wheel movement. Next open machine and check fuses, motor and sensors for motor-controller.

5.2 Runtime alarms

Alarm No	Description	Indication	Actions
5	Exchange cycle is not completed.	A/R and START buttons are flashing	<p>Check if something (bottle or cap) is obstructing the star wheel movement, remove the obstacle and press RESET button – depending on the position of the star wheel, the actions are different:</p> <ul style="list-style-type: none"> - Something is stopping the star wheel at the entrance: The star wheel reverses to start position, where the obstacle can be removed. Press the START button to resume production - Something is stopping the ejector arm from pushing out: The ejector arm is returned to the home position. The A/R is still flashing and when pressing the RESET button the ejector arm is moved out again to finish the exchange cycle. Press the START button to continue production.

Alarm No	Description	Indication	Actions
6	Capping cycle is not completed	A/R and CAP buttons are flashing	<p>There are a couple of situations, where this alarm will be initiated:</p> <ul style="list-style-type: none"> - The capping head is obstructed during the downwards movement: The capping head is returned to top position. If the bottle is in the correct position and nothing seems to obstruct the downwards movement, the machine has to be opened to investigate sensors and/or mechanical faults. - The alarm is initiated after the capping is finished: This could indicate to low air-pressure. If this not the case then the machine has to be opened to investigate sensors and/or mechanical faults. <p>Press the RESET button to reset the alarm and START button to continue production.</p>
7	Cap station (top-sensor) not in top during star wheel movement.	A/R, START and CAP buttons are flashing	<p>Check air pressure, open machine to check Press RESET button the reset the alarm.</p>
8	Adjust cycle is not completed	A/R and ADJUST buttons are flashing	<p>See the alarm description on alarm number 6 as the courses of the alarm are the same. Press RESET button the reset the alarm.</p>
9	N/A	N/A	N/A
10	Round table fault	A/R, START and FILL buttons are flashing	<p>Fault inside machine the round table toothed wheel is not turning; fault must be investigated inside machine: Check toothed belt, fuses and motor.</p>

5.3 Runtime warnings

A warning is used to turn the operator's attention to halt situations, which must be solved in order to continue production / running.

Alarm No	Description	Indication	Actions
1	Cap is not on bottle at Cap-detect position.	CAP button is flashing	There are two distinctly different ways of responding to this alarm/warning. <ul style="list-style-type: none"> - Put a CAP on the bottle and press CAP button to continue production. - Press the STEP button. This will end the automatic production (and capping) – the star wheel will move one position forward.
2	Filler is not starting on start signal	FILL button is flashing	Depending on conditions for the alarm/warning there are the following possible actions: <ul style="list-style-type: none"> - Start the filler manually. e.g. on a PF6 Press DISP+GO The FF30 will then continue and clear the warning. - Stop the filling mode by pressing the FILL button. The FF30 will continue automatic running without filling enabled. - Stop the automatic mode by pressing the START-button, the FF30 will leave fill mode and automatic mode.

5.4 Trouble shooting

Description of fault	Possible cause
The READY indicator does not go ON	<ul style="list-style-type: none"> - Compressed air is not connected - The star wheel is not in "home" position - The ejector arm is not in "home" position
The star wheel does not index	<ul style="list-style-type: none"> - The bottle inlet sensor does not see the bottle at the inlet - A workstation has not finished the cycle - The toothed belt needs tension - Check fuses
External filler does not start when a bottle is present under nozzle	<ul style="list-style-type: none"> - Missing or loose cable from FF30 to filler - The filler is not in "dispense mode"
Capping station runs even if cap is missing	<ul style="list-style-type: none"> - The cap sensor has been placed too low
Capping is not complete or torque is inconsistent	<ul style="list-style-type: none"> - Capping head is placed too high - The bottle slips in the star wheel during capping
The bottle ejector does not move the bottle to the outlet tray	<ul style="list-style-type: none"> - The ejector is not mounted correctly. - The toothed belt needs tension - Check fuses

6 Cleaning

6.1 Cleaning Frequency

As FF30 is not in direct contact with the dispensed product, daily cleaning might not be necessary.

Cleaning might be determined by local sop's and cleaning validations; but must never be with detergents more potent than the ones below.

6.2 Preparations for cleaning

Before cleaning the machine:

- Turn off the power
- Remove the filling nozzle and the filling tubes

6.3 Cleaning Guidance

Correct cleaning of the FF30 is carried out by washing it off with water or detergents, using a lint-free firmly wrung cloth or lint-free paper towel; subsequently the machine is wiped off with a dry cloth.

6.4 Detergents or cleaning agents

Normal cleaning agents such as tepid/medium hot water, ethyl alcohol (ethanol) 70% and may be used all over the machine.

The FF30 consists of stainless steel and anodized aluminium, and can be cleaned in several ways:

Cleaning of parts made of:	May be autoclaved	Can be cleaned with ethyl alcohol 70%	Can be cleaned with water and afterwards wiped off with dry a cloth
Stainless steel AISI304	X	X	X
Anodized aluminium	X	X	X
Polyacetal (POM)		X	X
Nylon (Compressed Air tubes)			X
Optical sensors*		X	X*

**Optical Sensors can be cleaned with alcohol, but over time this can cause a milky surface. Either avoid cleaning the sensor optics with solvents or be sure to wipe them immediately afterwards with a soft dry cloth.*

Recommendation:

Keep a log on the cleaning in order to keep a sense of perspective.

7 Maintenance & service

7.1 Maintenance

Note: Maintenance of drive systems includes accessing the base cabinet and should be carried out by technical staff, only.

7.1.1 Tension of toothed belt

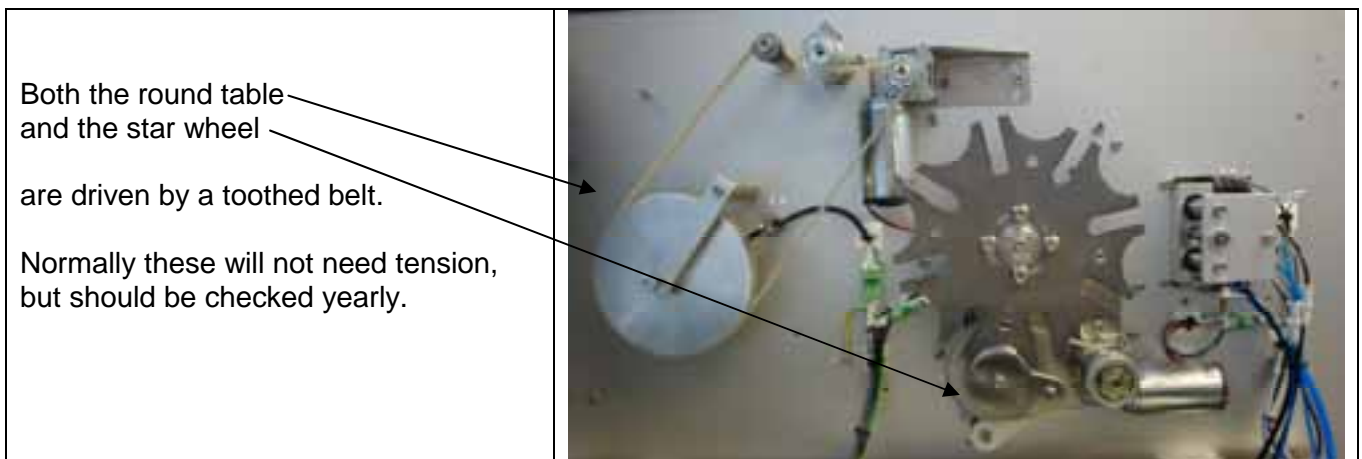

7.1.2 Capping unit

The capping air motor requires lubrication in order to function optimal. It is recommended to supply the air inlet with one drop of turbine oil before and after operation.

Recommended oil: Rocol Foodlube Multi-Lube with PTFE.

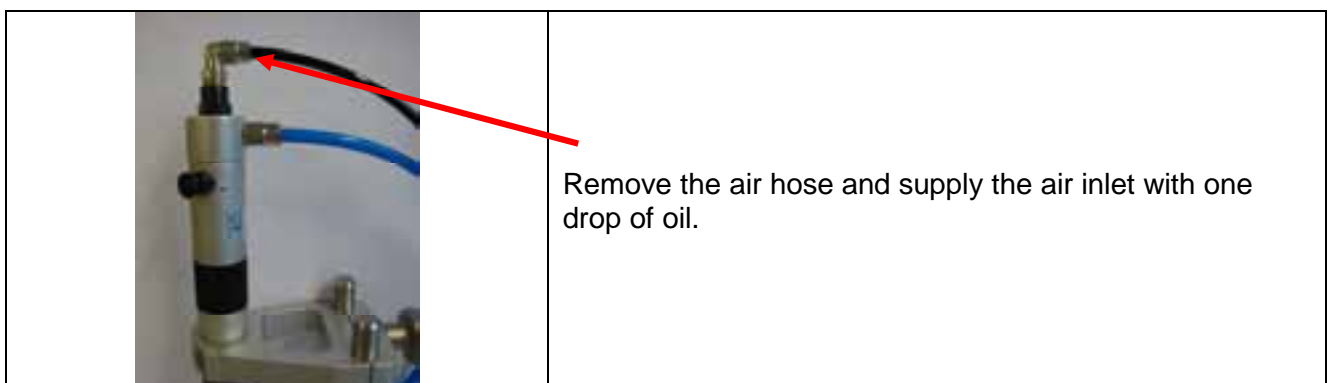

7.1.3 Star wheel and bottle ejector

The drive systems of the star wheel and the ejector arm needs regular lubrication.

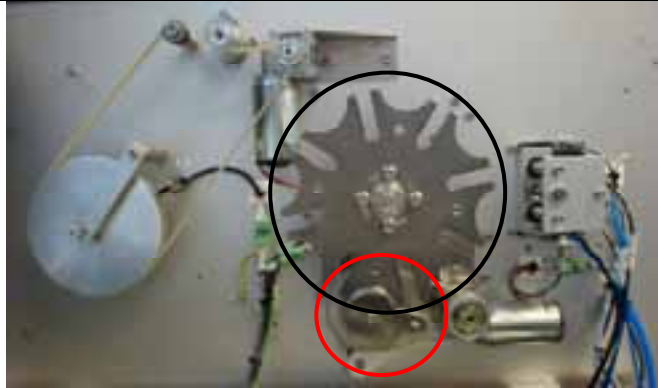

The contact faces between the carrier (red circle) and the Geneva wheel (black circle) should be lightly lubricated with a suitable grease; e.g. Dow Corning MOLYKOTE grease BR2 plus.
Note: it is the thin curved side of the wheel which is lubricated not the front or back.

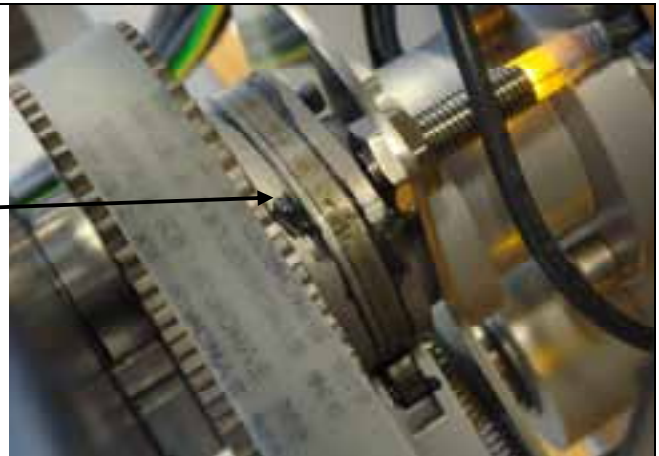
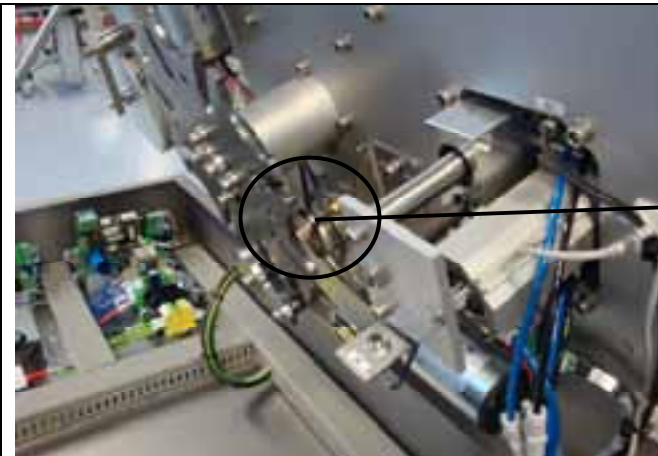

The contact faces between the cam of the toothed pulley and the ejector arm should be lightly lubricated with a suitable grease; e.g. Dow Corning MOLYKOTE grease BR2 plus.

7.2 Service

Should service be needed, please contact W-M Flexicon or your local supplier.

7.3 Methods and frequency of inspections for safety functions

Safety functions should be tested once a year:

- Emergency switch
When turned the entire FF30 is shut down

Keep a log and read the previous log recordings to present an overview of the machines state. After testing the safety functions the results must be recorded in the log.

8 Declaration of conformity

We WM-Flexicon A/S
Frejasvej 2-6
DK-4100 Ringsted

Declare on our sole responsibility that the bottle handling units:

Bottle handling and capping unit type	Item no	Model
FF30	92-350-xxx	62-315-000

To which this declaration relates is in conformity with the following standard(s):

DS EN/ISO 12100	Safety of machinery - Basic concepts, general principles of design
DS/EN 60204	Safety of machinery – Electrical equipment of machines

According to the provisions in the Directives:

2006/42/EC	On the approximation of the laws of the Member States relating to machinery
2006/95/EC	On the harmonization of the laws of Member States relating to electrical equipment designed for use within certain voltage limits
2004/108/EC	On the approximation of the laws of the Member States relating to electromagnetic compatibility

January 2010

Signature:

Ringsted, Denmark

Jørn Jeppesen, Development Manager